



ORACLE®

Oracle 12c ASM 新功能展示

Kamran Aghayev A.
Oracle 认证大师, ACE 总监

关于我

- **Azercell**电信公司**DBA**团队负责人
- **Oracle**认证大师
- **Oracle ACE**总监
- “**RMAN** 的备份和恢复”一书的作者
- 博客<http://www.kamranagayev.com>
- 阿塞拜疆甲骨文用户组主席（**AzerOUG**）



ORACLE®
ACE Director



在座的必要调查

- 有多少人使用**ASM**?
- 有多少人在生产环境中使用 **Oracle 12c** 数据库?
- 有多少人使用过任何**Oracle 12c ASM** 的新功能?

Oracle 12c ASM 新功能

- Oracle Flex ASM
- ASM 互联 – ASM专用网络
- ASM磁盘组相关的新功能
 - 失败组维修时间
 - ASM磁盘故障处理的改进
 - 更快的磁盘重新同步和更换
 - ASM磁盘清理
 - ASM远程访问

Oracle Flex ASM

- Deploy Oracle Flex ASM: Architecture Options
 - Oracle Flex ASM for new Oracle 12c Database Deployment:

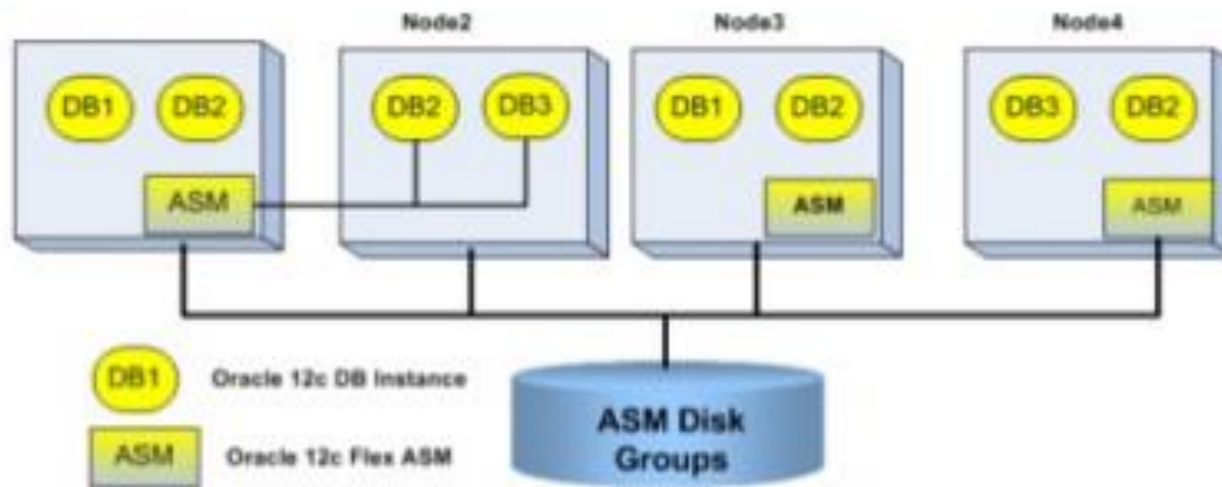

Oracle Flex ASM

The screenshot shows the Oracle Grid Infrastructure installation wizard at Step 10 of 19, titled "Storage Option Information". The window title is "Oracle Grid Infrastructure - Setting up Grid Infrastructure - Step 10 of 19". The Oracle logo and "GRID INFRASTRUCTURE 12c" are visible in the top right corner. On the left, a navigation pane lists various steps, with "Storage Option" selected and highlighted. Below the navigation pane, the main content area contains the following text and options:

You can place Oracle Cluster Registry (OCR) files and voting disk files on Oracle ASM storage, or on a file system.

- Use standard ASM for storage
Choose this option to configure Local Oracle ASM in this cluster and store OCR and voting disk files on it. ASM instance will be configured on all nodes of the cluster.
- Use Oracle Flex ASM for storage
Choose this option to configure OCR and voting disks on ASM storage. ASM instance will be configured on reduced number of cluster nodes.
- Use Shared File System
Choose this option to configure OCR and voting disk files on an existing shared file system.

At the bottom of the window, there are four buttons: "Help", "< Back", "Next >", "Install", and "Cancel".

Oracle Flex ASM

展示Oracle ASM 集群的当前模式。

```
[oracle@node1 ~]$ asmcmd showclustermode  
ASM cluster : Flex mode enabled
```

Oracle Flex ASM – Get the status of Flex ASM

```
[oracle@node1 ~]$ srvctl status asm -detail
```

```
ASM is running on node1,node2,node3
```

```
ASM is enabled.
```

```
[oracle@node1 database]$ srvctl config asm
```

```
ASM home: /u01/app/oracle/product/12.0.1/db_1
```

```
Password file: +DATA/orapwASM
```

```
ASM listener: LISTENER
```

```
ASM instance count: 3
```

```
Cluster ASM listener: ASMNET1LSNR_ASM
```

```
[oracle@node1 database]$
```

Oracle Flex ASM —增加/减少实例数

```
[oracle@node1 ~]$ srvctl modify asm -count 2
```

```
[oracle@node1 database]$ srvctl status asm -detail  
ASM is running on node1,node2  
ASM is enabled.
```

Oracle Flex ASM —增加/减少实例数

```
oracle@node1 database]$ srvctl start asm -n node3
```

```
PRCR-1013 : Failed to start resource ora.asm
```

```
PRCR-1064 : Failed to start resource ora.asm on node node3
```

```
CRS-2552: There are no available instances of resource  
'ora.asm' to start.
```

```
[oracle@node1 database]$ srvctl modify asm -count 3
```

```
[oracle@node1 database]$ srvctl status asm -detail
```

```
ASM is running on node1,node2
```

```
ASM is enabled.
```

```
[oracle@node1 database]$ srvctl start asm -n node3
```

```
[oracle@node1 database]$ srvctl status asm -detail
```

```
ASM is running on node1,node2,node3
```

```
ASM is enabled.
```

```
[oracle@node1 database]$
```

Oracle Flex ASM —增加/减少实例数

node1

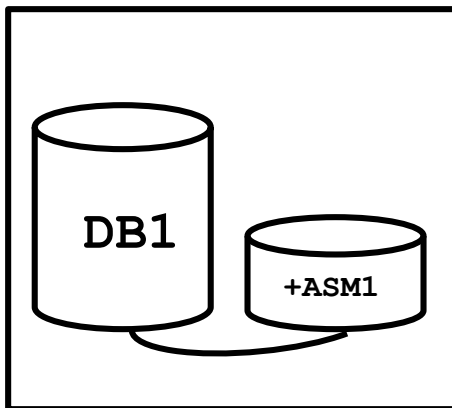

node2

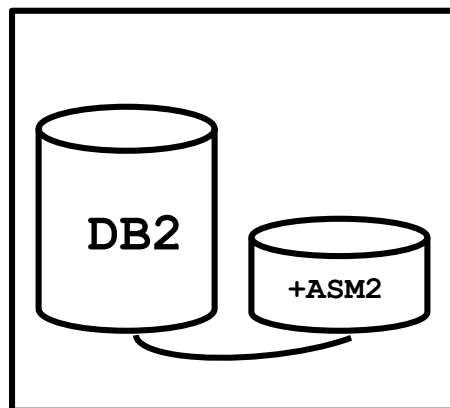

node3

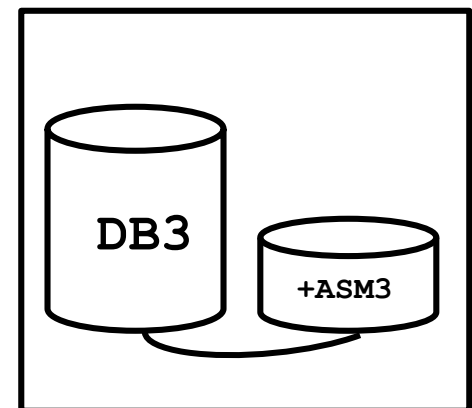

Oracle Flex ASM —增加/减少实例数

```
[oracle@node1 database]$ srvctl modify asm -count 2
```

node1

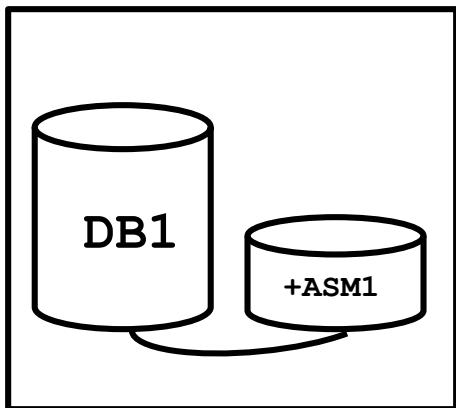

node2

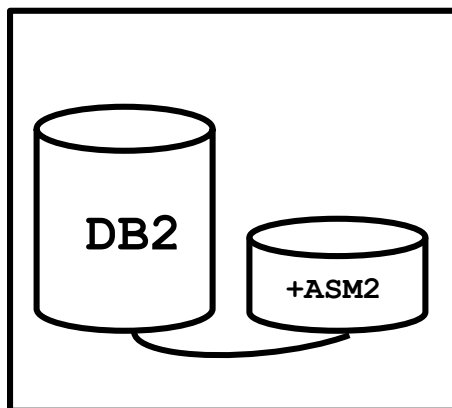

node3

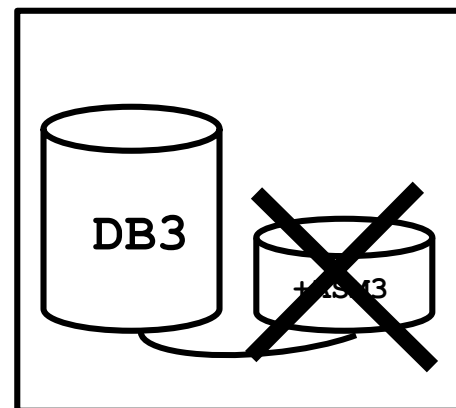

Oracle Flex ASM —增加/减少实例数

```
[oracle@node1 database]$ srvctl modify asm -count 2
```

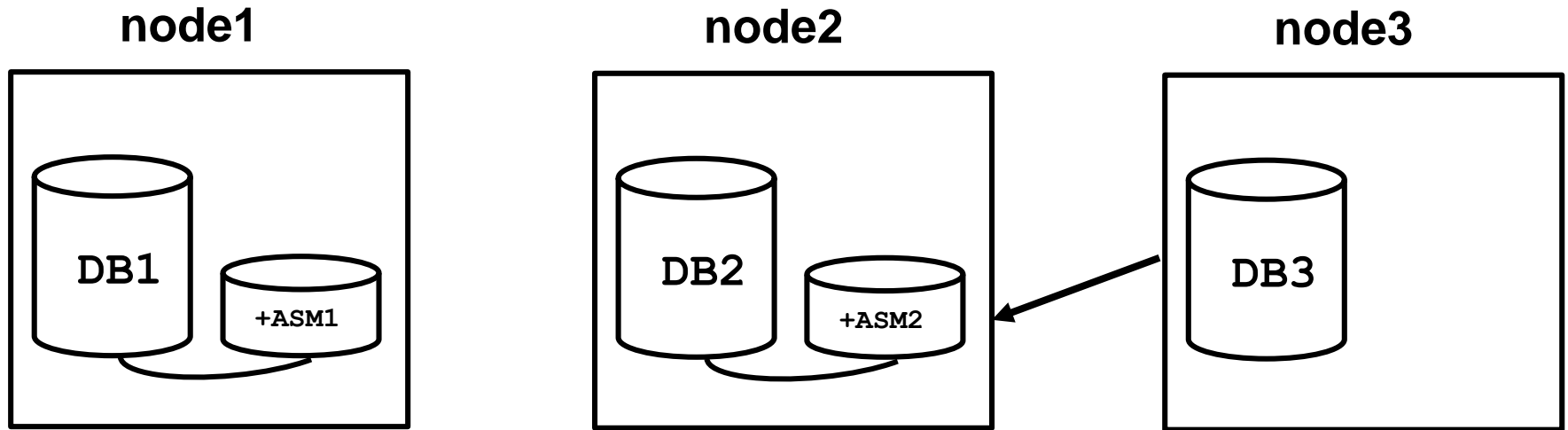

```
[oracle@node1 ~]$ srvctl status asm -detail
```

ASM is running on **node1,node2**

Oracle Flex ASM —增加/减少实例数

NOTE: ASMB process exiting due to ASM instance shutdown (inactive for 3 seconds)

NOTE: ASMB clearing idle groups before exit

Tue Nov 03 05:36:53 2015

NOTE: client +ASM3:+ASM deregistered

Tue Nov 03 05:36:55 2015

NOTE: client RACDB3:RACDB should failover

Shutting down instance (immediate)

Tue Nov 03 05:37:01 2015

NOTE: client RACDB3:RACDB id 0x10001 has reconnected to ASM inst +ASM2

Tue Nov 03 05:37:01 2015

NOTE: ASMB registering with ASM instance as client 0x10001 (reg:457157236)

NOTE: ASMB connected to ASM instance +ASM2 (Flex mode; client id 0x10001)

NOTE: ASMB rebuilding ASM server state

NOTE: ASMB rebuilt 1 (of 1) groups

NOTE: ASMB rebuilt 21 (of 21) allocated files

NOTE: fetching new locked extents from server

NOTE: 0 locks established; 0 pending writes sent to server

SUCCESS: ASMB reconnected & completed ASM server state

Oracle Flex ASM —增加/减少实例数

```
SQL> SELECT inst_id, group_number, instance_name, db_name, status FROM  
gv$asm_client ORDER BY instance_name;
```

INST_ID	GROUP_NUMBER	INSTANCE_NAME	DB_NAME	STATUS
1	1	+ASM1	+ASM	CONNECTED
2	1	+ASM2	+ASM	CONNECTED
1	1	RACDB1	RACDB	CONNECTED
2	1	RACDB2	RACDB	CONNECTED
2	1	RACDB3	RACDB	CONNECTED

Oracle Flex ASM —增加/减少实例数

```
[oracle@node1 database]$ srvctl modify asm -count 1
```

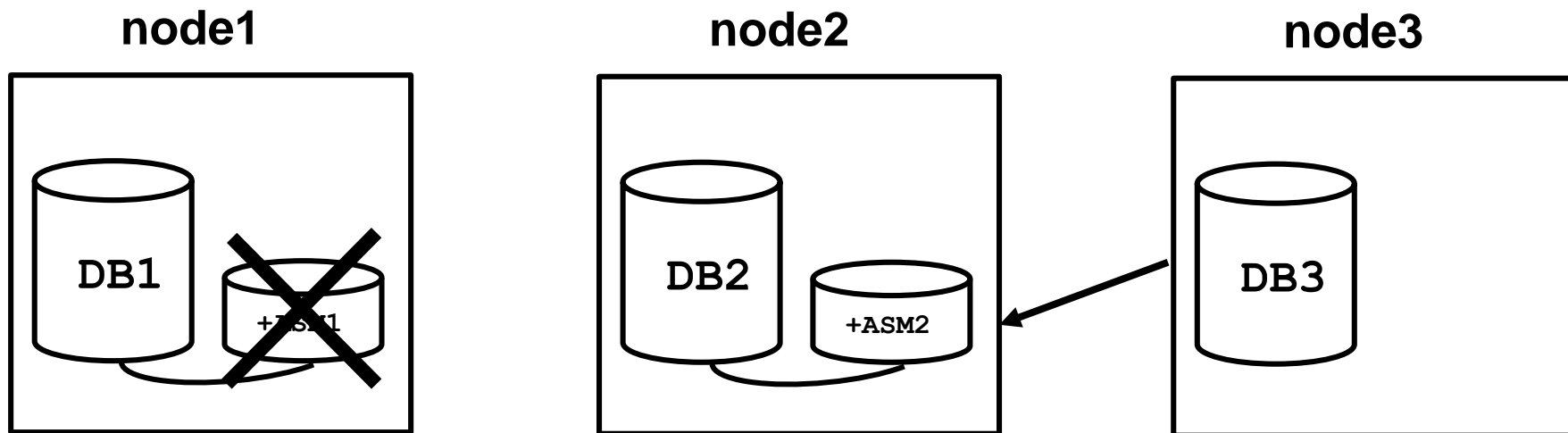

Oracle Flex ASM —增加/减少实例数

```
[oracle@node1 database]$ srvctl modify asm -count 1
```

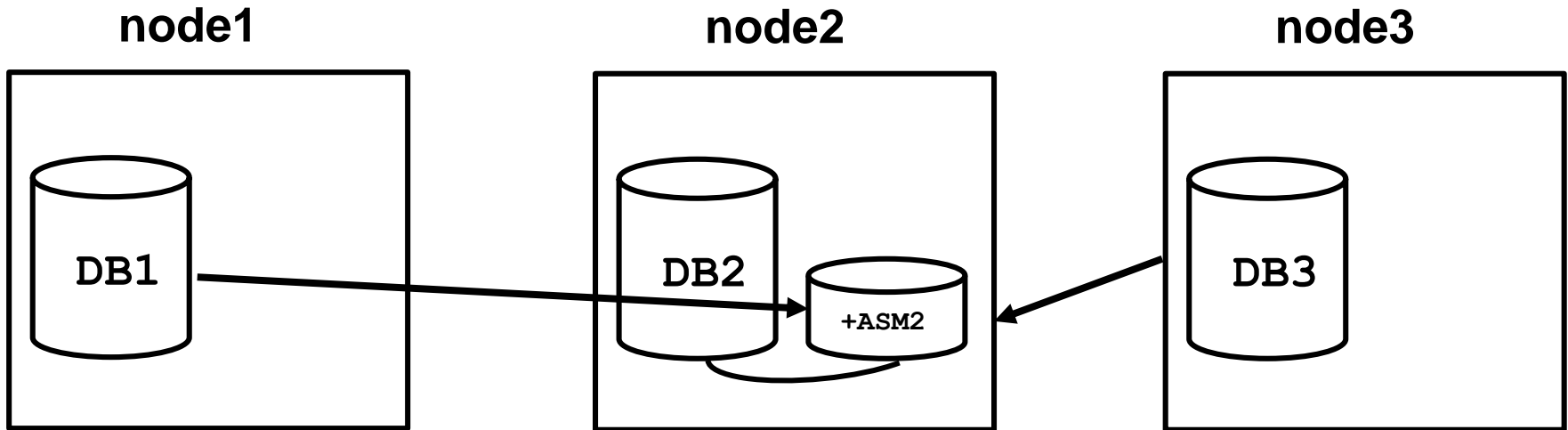

```
[oracle@node1 ~]$ srvctl status asm -detail
```

```
ASM is running on node2
```

```
ASM is enabled.
```

Oracle Flex ASM —增加/减少实例数

Tue Nov 03 05:50:31 2015

NOTE: ASMB registering with ASM instance as client 0x10002

NOTE: ASMB connected to ASM instance +ASM2 (Flex mode; client id 0x10002)

NOTE: ASMB rebuilding ASM server state

NOTE: ASMB rebuilt 1 (of 1) groups

```
SQL> SELECT inst_id, group_number, instance_name, db_name, status FROM
gv$asm_client ORDER BY instance_name;
```

INST_ID	GROUP_NUMBER	INSTANCE_NAME	DB_NAME	STATUS
2	1	+ASM2	+ASM	CONNECTED
2	1	RACDB1	RACDB	CONNECTED
2	1	RACDB2	RACDB	CONNECTED
2	1	RACDB3	RACDB	CONNECTED

Oracle Flex ASM —重新定位RDBMS实例

```
SQL> ALTER SYSTEM RELOCATE CLIENT 'RACDB1:RACDB';
```

System altered.

```
SQL> SELECT inst_id, group_number, instance_name, db_name, status FROM  
gv$asm_client ORDER BY instance_name;
```

INST_ID	GROUP_NUMBER	INSTANCE_NAME	DB_NAME	STATUS
2	1	+ASM2	+ASM	CONNECTED
1	1	RACDB1	RACDB	CONNECTED
2	1	RACDB2	RACDB	CONNECTED
2	1	RACDB3	RACDB	CONNECTED

Oracle Flex ASM —增加/减少实例数

```
[oracle@node2 trace]$ ps -ef | grep pmon
```

```
oracle    22402    1  0 01:28 ?        00:00:00 asm_pmon_+ASM3
```

```
[oracle@node2 database]$ kill -9 22402
```

```
NOTE: ASMB registering with ASM instance as client 0x10002
```

```
NOTE: ASMB connected to ASM instance +ASM1 (Flex mode; client
```

```
NOTE: ASMB rebuilding ASM server state
```

```
[oracle@node1 ~]$ srvctl status database -d RACDB
```

```
Instance RACDB1 is running on node node1
```

```
Instance RACDB2 is running on node node3
```

```
Instance RACDB3 is running on node node2
```

```
[oracle@node1 ~]$ srvctl status asm -detail
```

```
ASM is running on node1,node3
```

```
ASM is enabled.
```

ASM 互联 ...

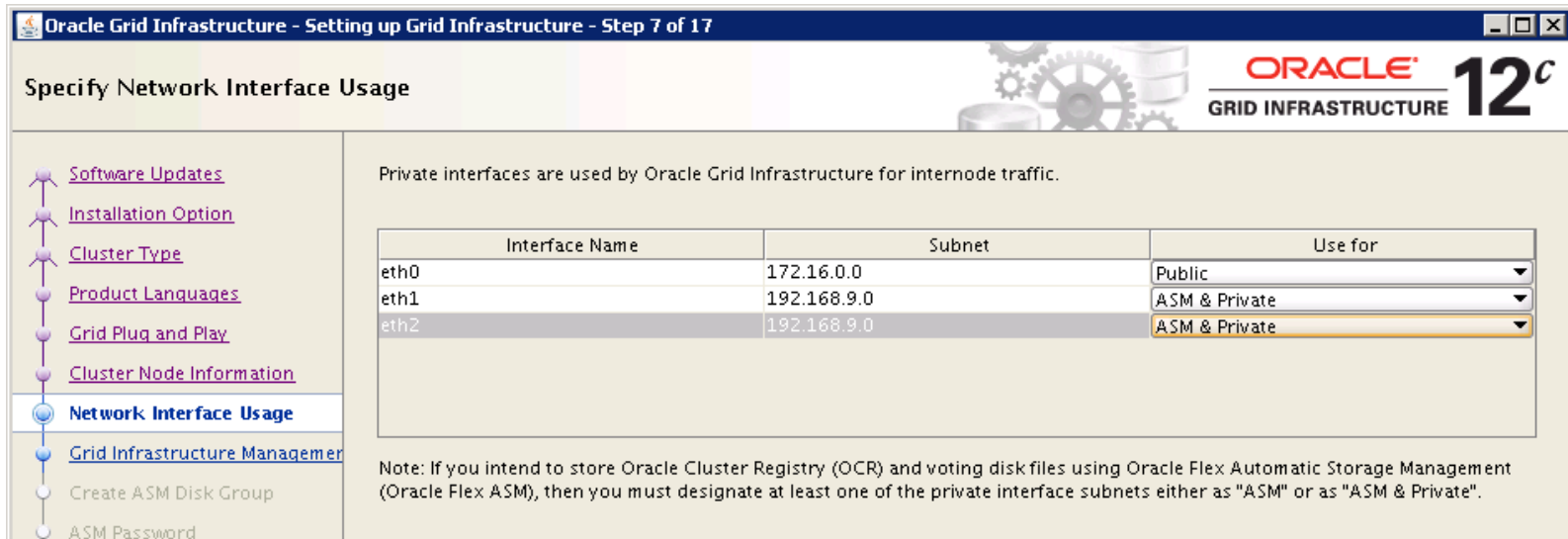

Oracle Grid Infrastructure - Setting up Grid Infrastructure - Step 7 of 17

Specify Network Interface Usage

Private interfaces are used by Oracle Grid Infrastructure for internode traffic.

Interface Name	Subnet	Use for
eth0	172.16.0.0	Public
eth1	192.168.9.0	ASM & Private
eth2	192.168.9.0	ASM & Private

Note: If you intend to store Oracle Cluster Registry (OCR) and voting disk files using Oracle Flex Automatic Storage Management (Oracle Flex ASM), then you must designate at least one of the private interface subnets either as "ASM" or as "ASM & Private".

```
[oracle@node1 ~]$ oifcfg getif
eth0 192.168.0.0 global public
eth1 192.168.1.0 global cluster_interconnect,asm
```

ASM 密码文件

```
ASMCMD> cd +DATA/ASM/PASSWORD
```

```
ASMCMD> ls -lt
```

Type	Redund	Striped	Time	Sys	Name
PASSWORD	UNPROT	COARSE	OCT 27 19:00:00	Y	pwdasm.256.894222589

```
ASMCMD> pwget --asm
```

```
+DATA/ASM/PASSWORD/pwdasm.282.894937839
```

```
ASMCMD>
```

```
[oracle@node1 ~]$ crsctl stat res ora.asm -p|grep PWFIL
```

```
PWFIL=+DATA/ASM/PASSWORD/pwdasm.282.894937839
```

ASM Password file

```
[oracle@node1 ~]$ orapwd file='+DATA' asm=y
```

```
Enter password for SYS:
```

```
[oracle@node1 ~]$
```

```
[oracle@node1 ~]$ sqlplus sys/oracle@node2:/+ASM as sysdba
```

```
SQL*Plus: Release 12.1.0.1.0 Production on Thu Nov 5 06:23:08 2015
```

```
Copyright (c) 1982, 2013, Oracle. All rights reserved.
```

```
Connected to:
```

```
Oracle Database 12c Enterprise Edition Release 12.1.0.1.0 - 64bit  
Production
```

```
With the Real Application Clusters and Automatic Storage Management  
options
```

```
SQL>
```

ASM Password file – 12c ASMCMD commands

pwcopy	Copies a password file to the specified location
pwcreate	Creates a password file at the specified location
pwdelete	Deletes a password file at the specified location
pwget	Returns the location of the password file
pwmove	Moves the location of the password file
pwset	Sets the location of the password file

showversion	To show the version of ASM you are running
showversion --softwarepatch	To know the patch level of the entire cluster
showclustermode	command shows if Flex ASM is enabled or not

ASM Password file – 12c ASMCMD 命令

```
ASMCMD> help pwcopy
```

```
pwcopy
```

```
Copy a password file from one disk group to another,  
from OS to a disk group, or from a disk group to OS
```

```
Synopsis
```

```
pwcopy [ --dbuniquename <string> | --asm ]  
<source_path> <destination_path>
```

```
Examples
```

```
ASMCMD [+] > pwcopy --asm +DG/mydir/mypwfile +DG1/pwfiles/mypwfile  
copying +DG/mypwfile -> +DG1/pwfiles/mypwfile
```

```
ASMCMD [+] > pwcopy +DG/mydir/mypwfile /home/asmuser/pwfiles/mypwfile  
copying +DG/mypwfile -> /home/asmuser/pwfiles/mypwfile
```

```
See Also
```

```
pwcreate pwdelete pwmove pwset pwget
```

ASM Password file —恢复ASM密码文件

如果ASM密码文件不可用，那集群件就不会显示

```
2014-02-02 14:05:43.885: [ OCRRAW][3619968576]proprinit: Could not open raw device
2014-02-02 14:05:43.887: [ OCRAPI][3619968576]a_init:16!: Backend init unsuccessful
: [26]
2014-02-02 14:05:43.888: [ CRSOCR][3619968576] OCR context init failure. Error:
PROC-26: Error while accessing the physical storage
ORA-01017: invalid username/password; logon denied
ORA-15077: could not locate ASM instance serving a required diskgroup
```

ASM Password file —恢复ASM密码文件



解除配置和重新配置集群！

ASM 密码文件- 备份 ASM 密码文件

```
ASMCMD> pwget --asm
```

```
ASMCMD> pwcopy --asm
```

```
+DATA/ASM/PASSWORD/pwdasm.original +DG_NEW/pwdasm.bak
```

以如下命令恢复它：

```
ASMCMD> pwcopy -asm +DG_NEW/pwdasm.bak +DG_NEW2/pwdasm_new
```

(Doc ID 1644005.1)

重命名磁盘

```
SQL> CREATE DISKGROUP mydg NORMAL REDUNDANCY  
        FAILGROUP fgroup1 DISK '/dev/asm-disk5'  
        FAILGROUP fgroup2 DISK '/dev/asm-disk6';
```

```
SQL> SELECT group_number, name, path FROM v$asm_disk
```

GROUP_NUMBER	NAME	PATH
2	MYDG_0000	/dev/asm-disk5
2	MYDG_0001	/dev/asm-disk6

重命名磁盘

```
SQL> alter diskgroup mydg dismount;
```

```
Diskgroup altered.
```

```
SQL> alter diskgroup mydg mount restricted;
```

```
Diskgroup altered.
```

```
SQL> alter diskgroup mydg rename disk 'MYDG_0000' to 'MYDG_DISK1',  
'MYDG_0001' to 'MYDG_DISK2';
```

```
Diskgroup altered.
```

```
SQL>
```

```
SQL> SELECT group_number, name, path FROM v$asm_disk
```

GROUP_NUMBER	NAME	PATH
2	MYDG_DISK1	/dev/asm-disk5
2	MYDG_DISK2	/dev/asm-disk6

更换磁盘

```
SQL> ALTER DISKGROUP MYDG ADD DISK '/dev/asm-disk7' NAME 'MYDG_DISK3';
```

```
SQL> ALTER DISKGROUP MYDG DROP DISK MYDG_DISK1;
```

```
SQL> ALTER DISKGROUP MYDG  
      ADD DISK '/dev/asm-disk7'  
      DROP DISK '/dev/asm-disk6' rebalance power 10;
```

```
SQL> ALTER DISKGROUP MYDG REPLACE DISK MYDG_DISK2 WITH '/dev/asm-disk7';
```

估算工作(V\$ASM_ESTIMATE)

```
SQL> EXPLAIN WORK FOR ALTER DISKGROUP mydg ADD DISK '/dev/asm-disk5';
```

Explained.

```
SQL> SELECT est_work FROM V$ASM_ESTIMATE;
```

```
EST_WORK
```

```
-----  
24
```

更快的再同步

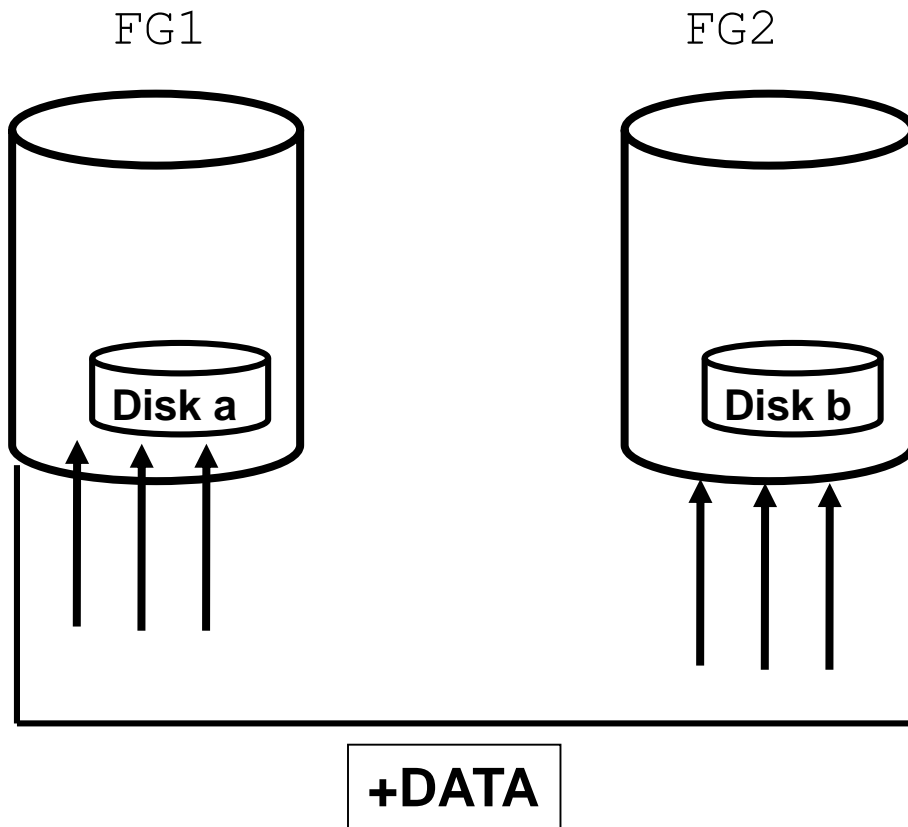

更快的再同步

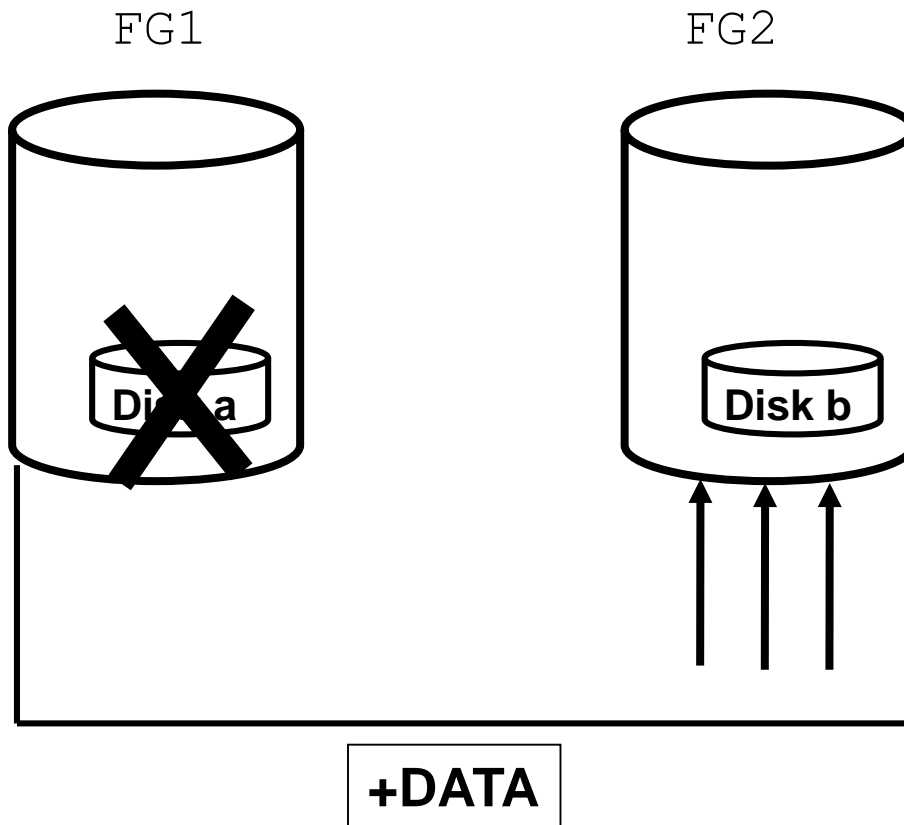

```
SQL> ALTER DISKGROUP mydg  
OFFLINE DISK MYDG_0001;
```

更快的再同步

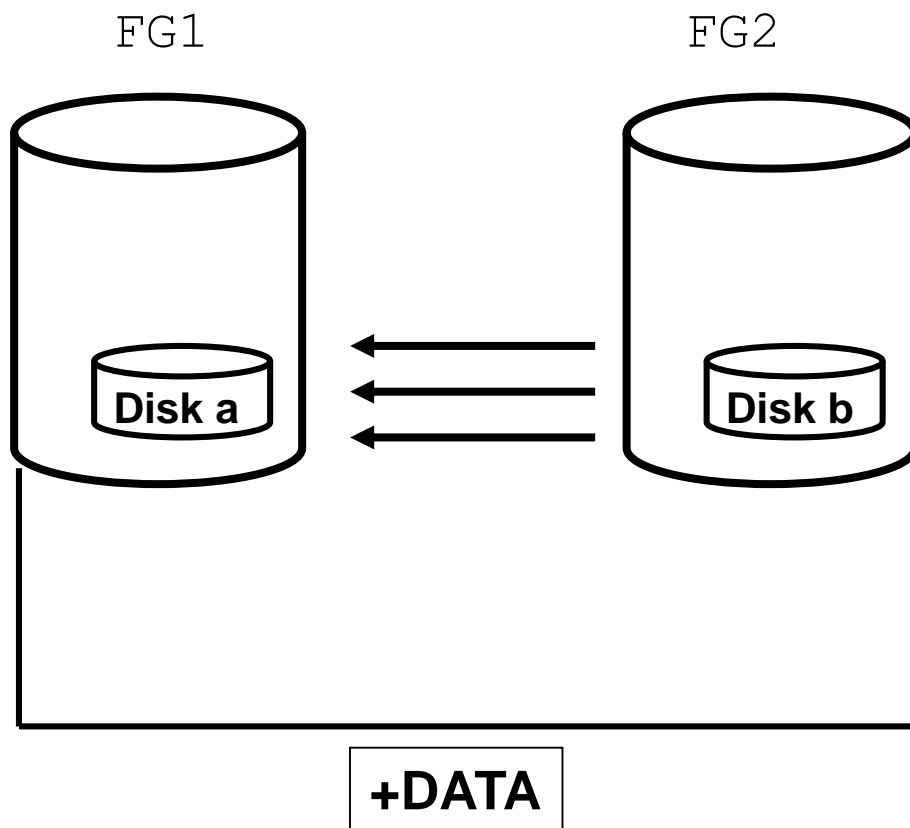

```
SQL> ALTER DISKGROUP mydg  
ONLINE DISK MYDG_0001  
POWER 10;
```

Resync is restartable!

失败组修复时间

```
SQL> CREATE DISKGROUP mydg NORMAL REDUNDANCY  
        FAILGROUP fgroup1 DISK '/dev/asm-disk5'  
        FAILGROUP fgroup2 DISK '/dev/asm-disk6';
```

```
SQL> ALTER DISKGROUP mydg SET ATTRIBUTE 'DISK_REPAIR_TIME'='1M';
```

```
SQL> ALTER DISKGROUP mydg OFFLINE DISK mydg_0001;
```

```
WARNING: Started Drop Disk Timeout for Disk 1 (MYDG_0001) in  
group 2 with a value 60
```

```
WARNING: Disk 1 (MYDG_0001) in group 2 will be dropped in:  
(60) secs on ASM inst 1
```

失败组修复时间

Thu Nov 12 10:28:18 2015

```
SQL> alter diskgroup MYDG drop disk MYDG_0001 force /* ASM SERVER */
```

注: GroupBlock outside rolling migration privileged region

Thu Nov 12 10:28:19 2015

```
SUCCESS: alter diskgroup MYDG drop disk MYDG_0001 force /* ASM SERVER */
```

```
SQL> SELECT group_number,name,value FROM v$asm_attribute  
WHERE group_number=2 ;
```

GROUP_NUMBER	NAME	VALUE
2	DISK_REPAIR_TIME	3.6h
2	FAILGROUP_REPAIR_TIME	24.0h

ASM磁盘清理

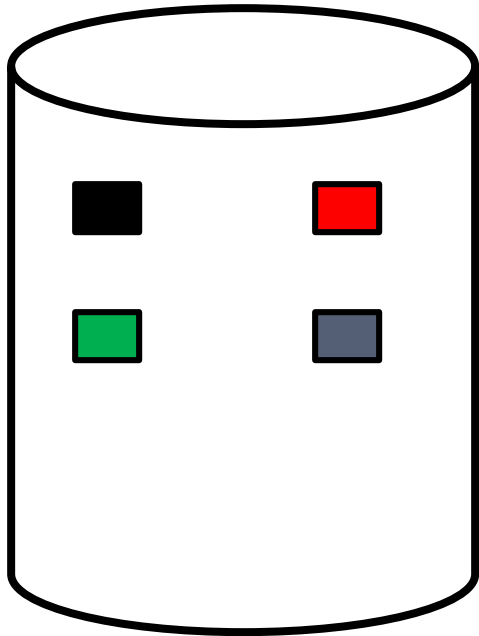

FGroup1

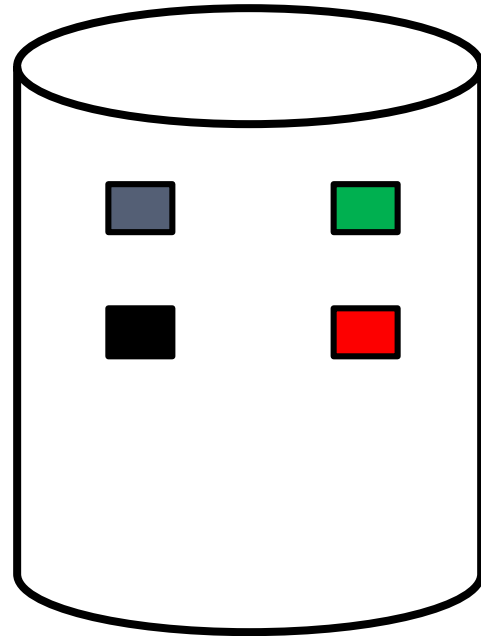

FGroup2

+DATA

ASM磁盘清理

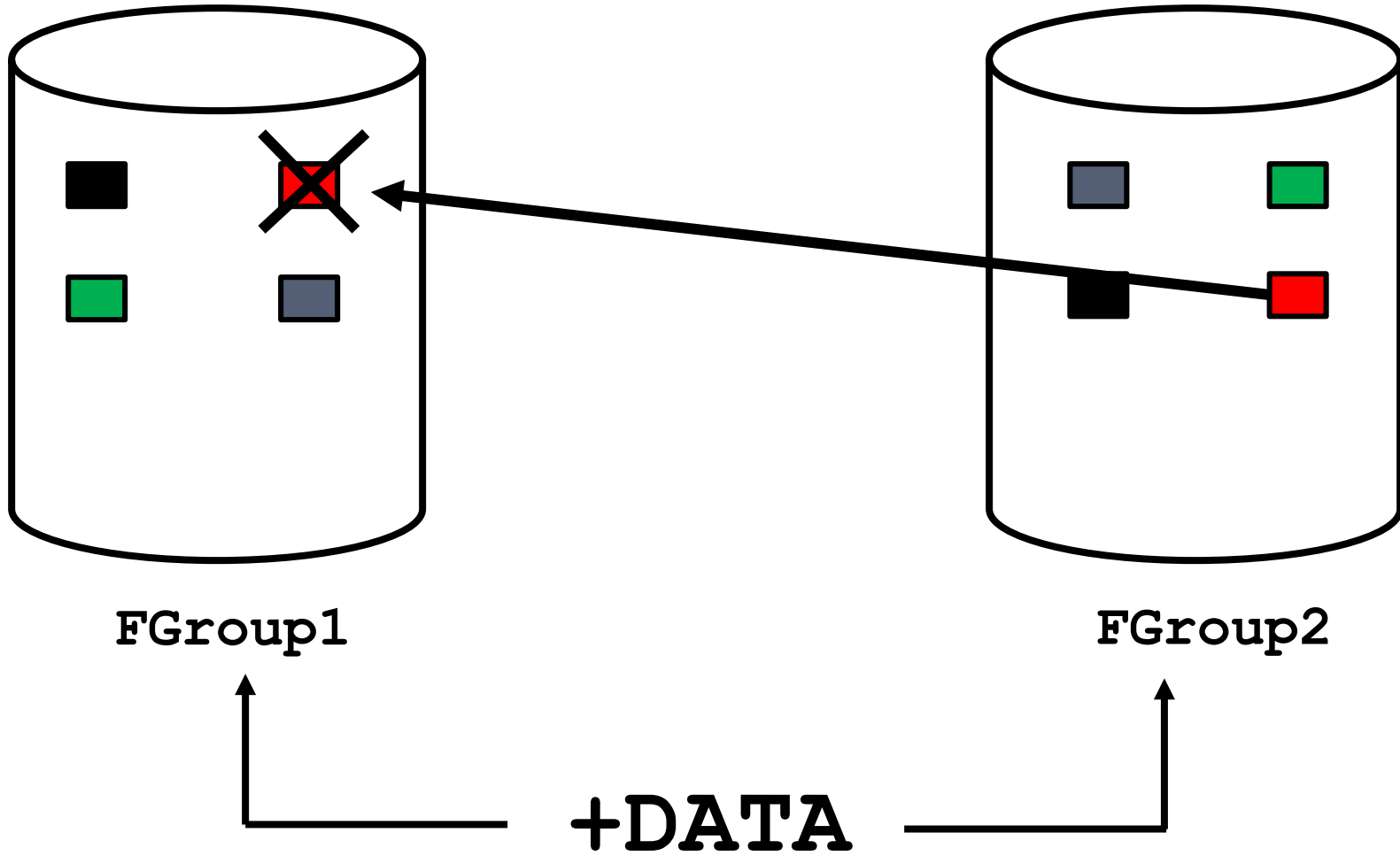

ASM磁盘清理

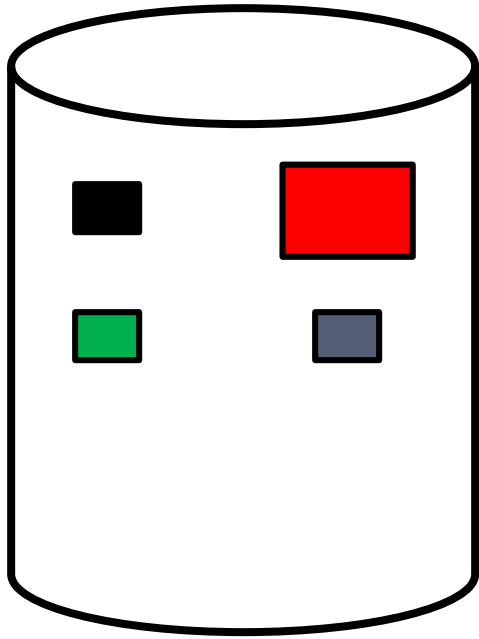

FGroup1

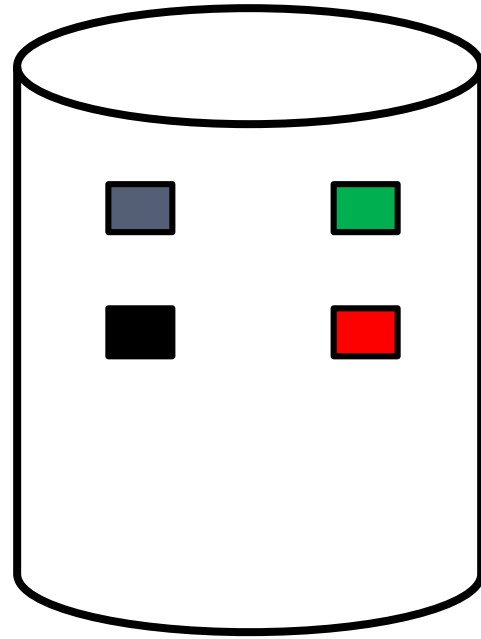

FGroup2

+DATA

ASM磁盘清理

```
SQL> CREATE DISKGROUP mydg NORMAL REDUNDANCY  
        FAILGROUP fgroup1 DISK '/dev/asm-disk5'  
        FAILGROUP fgroup2 DISK '/dev/asm-disk6';
```

ASM磁盘清理

```
SQL> CREATE TABLESPACE mytbs DATAFILE '+MYDG' SIZE 20M;
```

```
CREATE TABLE myt
```

```
(
```

```
  id      NUMBER,
```

```
  name    VARCHAR2 (10)
```

```
)
```

```
TABLESPACE mytbs;
```

```
INSERT INTO myt
```

```
  VALUES (1, 'mytest');
```

```
COMMIT;
```

```
ALTER SYSTEM FLUSH BUFFER_CACHE;
```

```
SELECT * FROM myt;
```

```
  ID NAME
```

```
-----
```

```
  1 mytest
```

ASM磁盘清理

```
select
rowid ,
to_number(utl_encode.base64_decode(utl_raw.cast_to_raw(lpad(substr(rowid,
1, 6), 8, 'A'))), 'XXXXXXXXXXXX') as objid,

to_number(utl_encode.base64_decode(utl_raw.cast_to_raw(lpad(substr(rowid,
7, 3), 4, 'A'))), 'XXXXXX') as filenum,

to_number(utl_encode.base64_decode(utl_raw.cast_to_raw(lpad(substr(rowid,
10, 6), 8, 'A'))), 'XXXXXXXXXXXX') as blocknum,

to_number(utl_encode.base64_decode(utl_raw.cast_to_raw(lpad(substr(rowid,
16, 3), 4, 'A'))), 'XXXXXX') as rowslot from myt;
```

ROWID	OBJID	FILENUM	BLOCKNUM	ROWSLOT
AAAWgqAAHAAAACHAAA	92202		7	0

ASM磁盘清理

135 - (1024/8=128) = 7 → 7th block in the second AU

AU size (1024kb)

db_block_size=8kb

```
SQL> SELECT GROUP_NUMBER, FILE_NUMBER, BYTES
       FROM v$asm_file
       WHERE group_number = 2;
```

GROUP_NUMBER	FILE_NUMBER	BYTES
2	256	20979712

ASM磁盘清理

```
SQL> SELECT PXN_KFFXP,  
           XNUM_KFFXP,  
           DISK_KFFXP,  
           AU_KFFXP,  
DECODE (LXN_KFFXP, 0, 'Primary', 1, 'Secondary', 'header metadata')  
       "AU type"  
FROM X$KFFXP  
WHERE NUMBER_KFFXP = 256 AND GROUP_KFFXP = 2  
ORDER BY 1;
```

PXN_KFFXP	XNUM_KFFXP	DISK_KFFXP	AU_KFFXP	AU type
0	0	1	52	Primary
1	0	0	52	Secondary
2	1	0	53	Primary
3	1	1	53	Secondary
4	2	1	54	Primary
5	2	0	54	Secondary

ASM磁盘清理

```
SQL> SELECT PXN_KFFXP,  
           XNUM_KFFXP,  
           DISK_KFFXP,  
           AU_KFFXP,  
DECODE (LXN_KFFXP, 0, 'Primary', 1, 'Secondary', 'header metadata')  
       "AU type"  
FROM X$KFFXP  
WHERE NUMBER_KFFXP = 256 AND GROUP_KFFXP = 2  
ORDER BY 1;
```

PXN_KFFXP	XNUM_KFFXP	DISK_KFFXP	AU_KFFXP	AU type
0	0	1	52	Primary
1	0	0	52	Secondary
2	1	0	53	Primary
3	1	1	53	Secondary
4	2	1	54	Primary
5	2	0	54	Secondary

ASM磁盘清理

```
[oracle@node1 ~]$ strings /dev/asm-disk5 | grep mytest  
mytest
```

```
[oracle@node1 ~]$ strings /dev/asm-disk6 | grep mytest  
mytest
```

```
[oracle@node1 ~]$ dd if=/dev/asm-disk5 bs=1024k count=1 skip=53  
of=/tmp/aud1  
1+0 records in  
1+0 records out  
1048576 bytes (1.0 MB) copied, 0.000862522 s, 1.2 GB/s
```

```
[oracle@node1 ~]$ strings /tmp/aud1 | grep mytest  
mytest
```

ASM磁盘清理

```
[oracle@node1 ~]$ dd if=/tmp/aud1 bs=8k count=1 skip=7 of=/tmp/aud2  
1+0 records in  
1+0 records out  
8192 bytes (8.2 kB) copied, 0.000573621 s, 14.3 MB/s
```

```
[oracle@node1 ~]$ strings /tmp/aud2 | grep mytest  
mytest
```

ASM磁盘清理

Size of data block : 8k
ASM disk: /dev/asm-disk5
ASM file number: 256
AU size: 1Mb (128*8k=1024)
Data block: 135 (second AU (>128))
Data block offset: 135-128=7
Allocation unit: 53
Block number: 53*128+7=6791

```
[oracle@node1 ~]$ dd if=/dev/asm-disk5 bs=8k count=1 skip=6791 of=/tmp/aud3  
1+0 records in  
1+0 records out  
8192 bytes (8.2 kB) copied, 0.000239265 s, 34.2 MB/s
```

```
[oracle@node1 ~]$ strings /tmp/aud3 | grep mytest  
mytest
```

ASM磁盘清理

```
[oracle@node1 ~]$ dd if=/dev/asm-disk5 bs=8k count=1 skip=6791 | od -a
```

```
0000000 ack  " nul nul bel nul  @ soh  ;  0  ) nul nul nul soh  
ack
```

```
0000020  a nak nul soh nul nul nul  *  h soh nul  :  0  ) nul
```

```
0000040 nul nul nul stx nul  2 nul nul nul  @ soh enq nul can nul
```

```
0000160  w  us nul soh nul  vt  us nul nul nul nul nul nul nul nul
```

```
0000200 nul nul nul nul nul nul nul nul nul nul nul nul nul nul
```

```
0017760 soh stx stx  A stx ack  m y t e s t soh ack  ;
```

```
0
```

```
1+0 records in
```

```
1+0 records out
```

```
0020000
```

```
8192 bytes (8.2 kB) copied, 0.00115169 s, 7.1 MB/s
```

不要在生产环境中
尝试!!!



ASM磁盘清理

```
[oracle@node1 ~]$ dd if=/dev/zero of=/dev/asm-disk5 bs=8k count=1  
seek=6791
```

```
1+0 records in
```

```
1+0 records out
```

```
8192 bytes (8.2 `kB) copied, 0.000852265 s, 9.6 MB/s
```

```
[oracle@node1 ~]$ dd if=/dev/asm-disk5 bs=8k count=1 skip=6791 | od -a
```

```
0000000 nul nul nul nul nul nul nul nul nul nul nul nul nul
```

```
1+0 records in
```

```
1+0 records out
```

```
0020000
```

```
8192 bytes (8.2 kB) copied, 0.000424802 s, 19.3 MB/s
```

```
[oracle@node1 ~]$
```

A problem has been detected and Windows has been shut down to prevent damage to your computer.

UNMOUNTABLE_BOOT_VOLUME

If this is the first time you've seen this error screen, restart your computer. If this screen appears again, follow these steps:

Check to make sure any new hardware or software is properly installed. If this is a new installation, ask your hardware or software manufacturer for any Windows updates you might need.

If problems continue, disable or remove any newly installed hardware or software. Disable BIOS memory options such as caching or shadowing. If you need to use Safe Mode to remove or disable components, restart your computer, press F8 to select Advanced Startup Options, and then select Safe Mode.

Technical Information:

*** STOP: 0x000000ED (0x80F128D0, 0xc000009c, 0x00000000, 0x00000000)

ASM磁盘清理

```
ALTER SYSTEM FLUSH BUFFER_CACHE;
```

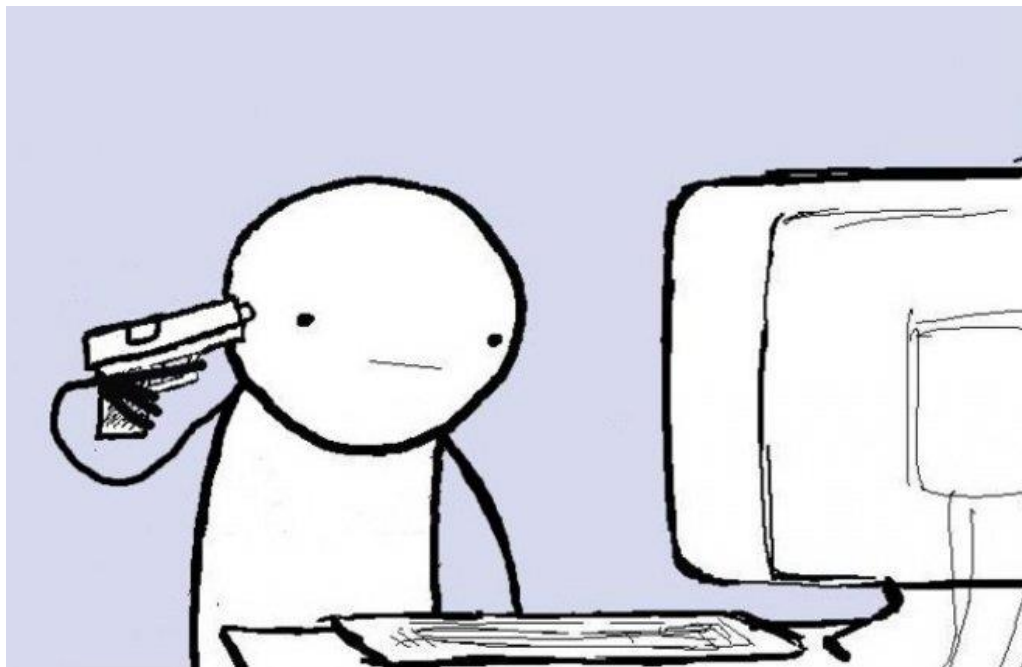

```
SELECT * FROM myt;
```

```
ID NAME
```

```
-----
```

```
1 mytest
```

ASM磁盘清理

Corrupt block relative dba: 0x01c00087 (file 7, block 135)

Completely zero block found during multiblock buffer read

Reading datafile '+MYDG/RACDB/DATAFILE/mytbs.256.895397209' for corruption at rdba: 0x01c00087 **(file 7, block 135)**

Read datafile mirror 'MYDG_0000' (file 7, block 135) found same corrupt data (no logical check)

Read datafile mirror '**MYDG_0001**' (file 7, block 135) **found valid data**

Repaired corruption at (file 7, block 135)

ASM磁盘清理

```
[oracle@node1 ~]$ dd if=/dev/asm-disk5 bs=8k count=1 skip=6791 | od -a
```

```
0000000  ack  "  nul  nul  bel  nul  @  soh  ;  0  )  nul  nul  nul  soh
ack
```

```
0000020  a  nak  nul  soh  nul  nul  nul  *  h  soh  nul  :  0  )  nul
```

```
0000040  nul  nul  nul  stx  nul  2  nul  nul  nul  @  soh  enq  nul  can  nul
```

```
0000160  w  us  nul  soh  nul  vt  us  nul  nul  nul  nul  nul  nul  nul  nul
```

```
0000200  nul  nul  nul  nul  nul  nul  nul  nul  nul  nul  nul  nul  nul  nul
```

```
0017760  soh  stx  stx  A  stx  ack  m  y  t  e  s  t  soh  ack  ;
```

```
0
```

```
1+0 records in
```

```
1+0 records out
```

```
0020000
```

```
8192 bytes (8.2 kB) copied, 0.00115169 s, 7.1 MB/s
```

ASM磁盘清理

```
SQL> ALTER DISKGROUP mydg SCRUB REPAIR;
```

```
SQL> ALTER DISKGROUP mydg SCRUB POWER MAX(HIGH, AUTO);
```

```
SQL> ALTER DISKGROUP mydg SCRUB DISK mydg_0000 REPAIR;
```

```
SQL> ALTER DISKGROUP mydg SCRUB FILE  
'+MYDG/RACDB/DATAFILE/USERS.331.34234515' REPAIR;
```

Thanks for coming!!

谢谢

<http://www.kamranagayev.com>

<http://www.facebook.com/KamranAgayev>

<http://www.twitter.com/KamranAgayev>